

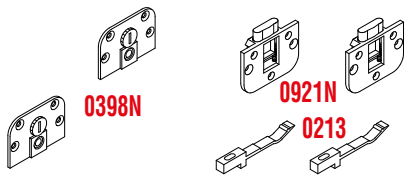



KIT 0921-398 NN - MAX 30 KG



Legenda KIT / Kit Legend

0398N	Carrello inferiore con eccentrico di regolazione <i>Lower truck with adjusting eccentric</i>
0213	Fermo superiore per profilo Art. 0211 <i>Upper stopper for profile Art. 0211</i>
0921N	Catenacciolo superiore <i>Upper security chain</i>

Legenda altri componenti Legend other items

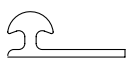
0211		Profilo plastica superiore <i>Upper plastic profile</i>
0380		Profilo alluminio inferiore <i>Lower aluminium profile</i>
0300		Profilo alluminio inferiore <i>Lower aluminium profile</i>

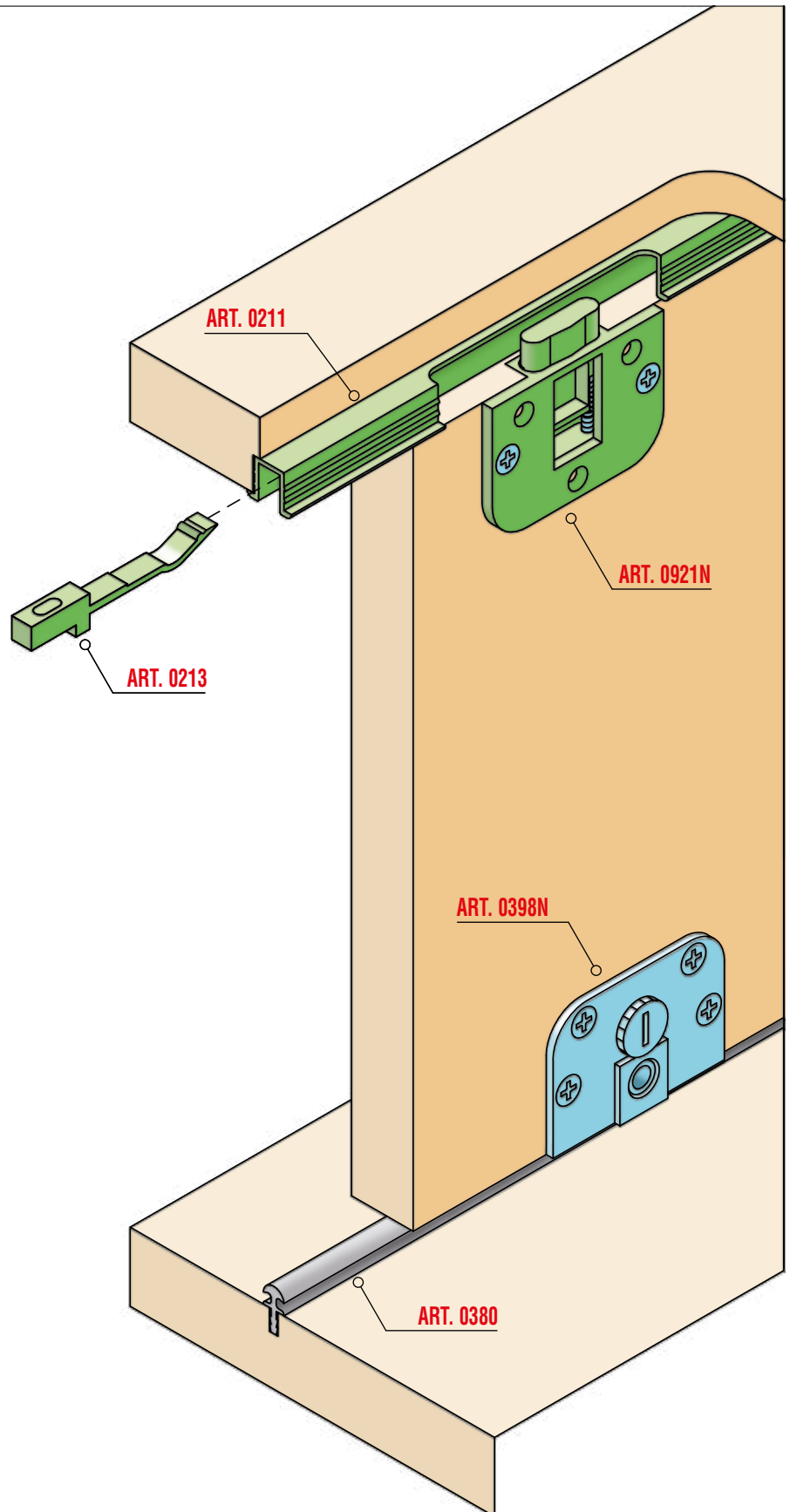



Sistemi scorrevoli per mobili / Sliding systems for furniture

Sezione verticale / Vertical section

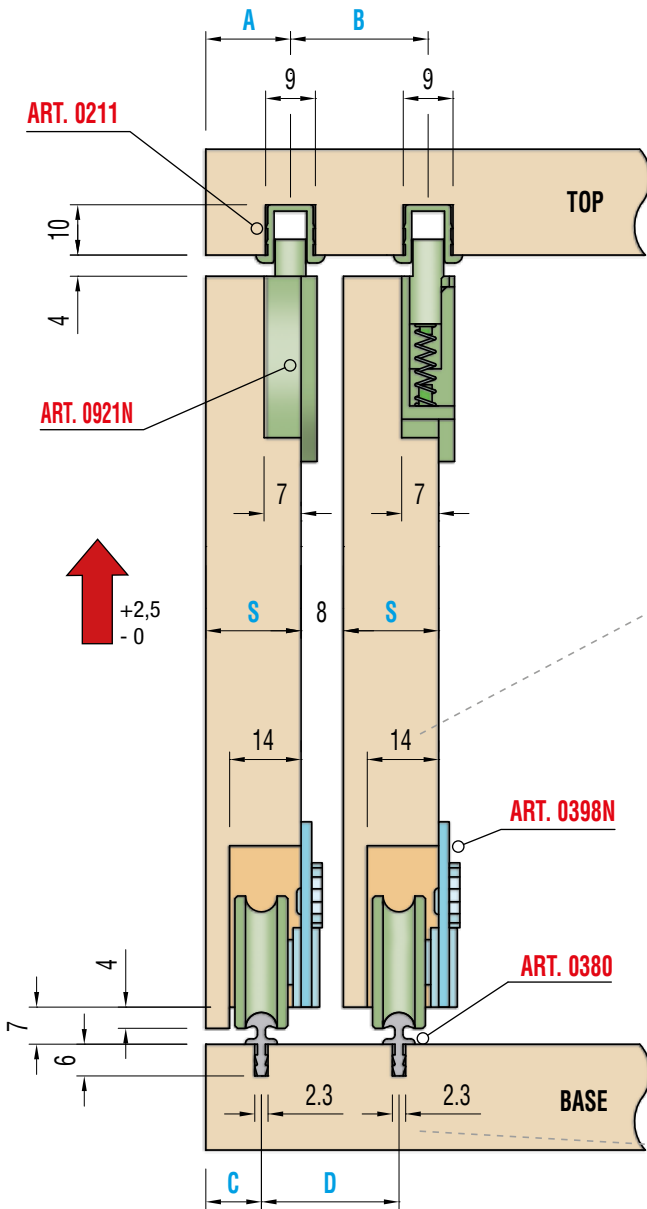

Peso massimo anta Kg. 30
Maximum door weight Kg 30

A =	S* -2
B =	S* +8
C =	S* -7,5
D =	S* +8
H =	X -11

S* (spessore / thickness)
min.18

Variante Special version

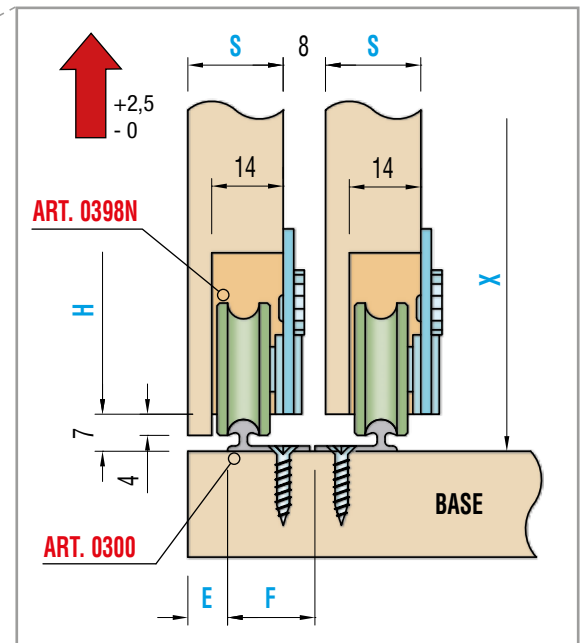

E =	S* -10,5
F =	S* -1,5
H =	X -11

Schema Foratura ante / Doors drilling

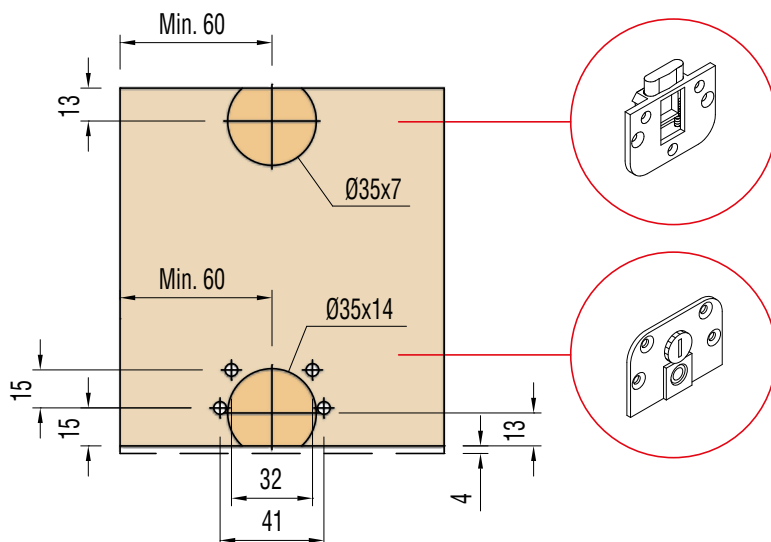

Schema di montaggio / Assembling

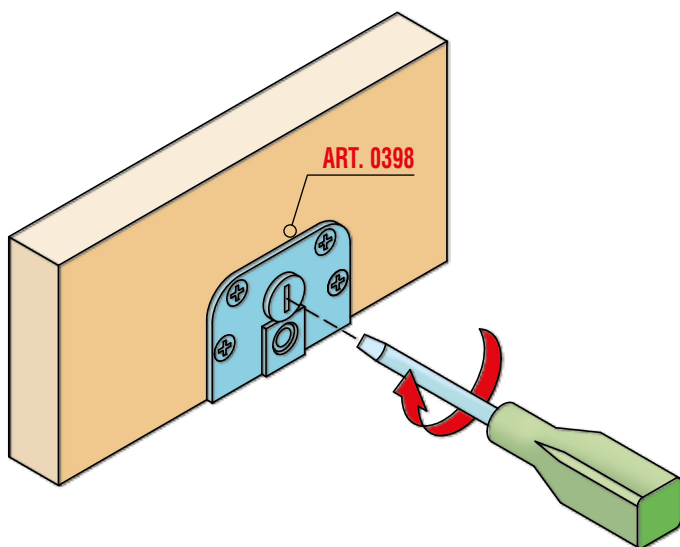

REGOLAZIONE CARRELLO ART.0398 ADJUSTING TRUCK ART.0398

Montare l'anta sul mobile e se necessario, regolarla ruotando l'eccentrico con un cacciavite.

Fit the door to the furniture piece, if necessary adjust it by turning the eccentric by screw-driver.

MONTAGGIO ANTE CON ART.0320 E 0390 FITTING OF DOORS CON ART.0320 E 0390

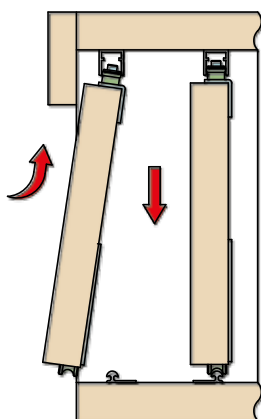

MONTAGGIO ANTE CON ART.0211 E 0902 FITTING OF DOORS CON ART.0211 E 0902

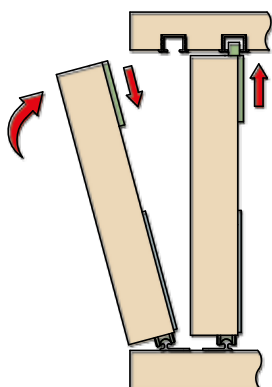

MONTAGGIO ED USO DEI CARRELLI REGOLABILI ART.0304

1

Montare sull'anta i carrelli ART.0304 avvitando le viti nei fori asolati inferiori senza stringerle.

Fit trucks ART.0304 to the door and turn the screws in the lower slots without tightening.

2

Montare l'anta sul mobile e, se necessario, regolarla ruotando l'eccentrico con una chiave esagonale da mm 6.

Fit the door to the furniture piece. If necessary, adjust it by turning the eccentric by means of a mm 6 hexagonal wrench.

3

Infine stringere le viti precedentemente montate nei fori inferiori e bloccare il carrello avvitando ancora le viti nei fori superiori.

Then tighten the screws previously inserted into the lower slots and lock the truck by tightening the screws in the upper slots.

FITTING AND USE THE ADJUSTABLE TRUCKS ART.0304

1

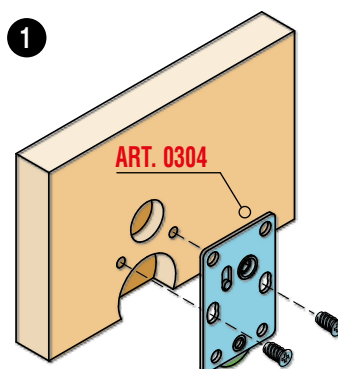

2

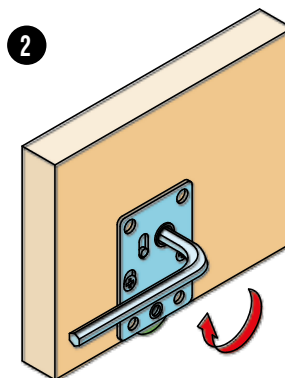

3

